



Fiyatlar

F Slope 1 / F Slope 2

(Hesap temeli: En E, Yükseklik Y1)

Parça adedi	3					3					3				
	50					60					70				
En cm															
Fiyat grubu	0	1	2	3	4	0	1	2	3	4	0	1	2	3	4
Yüks. 80	138	144	153	159	168	147	155	167	173	183	157	165	180	186	200
cm 90	142	148	160	167	176	152	160	174	181	193	161	172	187	197	210
100	146	152	167	172	184	156	164	181	188	203	165	177	197	206	220
110	150	159	172	180	192	160	171	187	198	212	171	182	204	214	232
120	152	163	180	187	201	163	176	197	206	221	175	188	212	223	243
130	156	169	184	194	209	168	181	203	213	231	179	194	220	232	253
140	162	173	192	204	218	173	186	210	222	242	183	201	228	242	265
150	167	178	201	209	227	177	192	218	230	251	187	206	237	251	275
160	168	182	205	216	237	180	198	224	239	262	193	212	245	261	289
170	172	186	211	223	244	184	203	232	247	271	198	218	253	270	300
180	175	190	218	231	254	188	208	240	255	282	203	224	261	280	310
190	181	199	225	239	263	194	214	248	264	294	207	230	270	291	324
200	185	203	232	248	271	199	219	255	273	303	211	237	279	300	334
210	188	207	239	255	282	203	224	263	282	314	216	243	289	309	346
220	192	213	247	264	291	207	231	271	293	325	221	249	297	321	358
230	197	217	253	271	300	211	237	279	301	335	225	255	305	330	370
240	200	223	259	278	309	215	243	288	309	345	231	262	314	340	382
250	206	228	267	289	318	220	248	296	319	356	236	268	324	350	394
260	212	236	275	298	332	227	255	305	330	370	242	275	334	361	409

Parça adedi	3					3					4				
	80					90					100				
En cm															
Fiyat grubu	0	1	2	3	4	0	1	2	3	4	0	1	2	3	4
Yüks. 80	179	188	206	214	228	197	208	227	236	252	209	221	243	253	271
cm 90	184	197	214	224	241	203	214	237	248	266	214	229	253	266	288
100	188	203	223	235	252	208	222	247	259	280	220	237	264	279	302
110	194	209	233	246	266	213	229	257	271	295	227	245	275	293	318
120	200	215	243	255	278	219	237	268	284	308	232	253	289	305	333
130	205	222	252	267	293	224	245	278	296	324	239	261	300	318	349
140	210	229	261	278	304	230	252	290	307	337	245	269	310	331	365
150	215	236	270	289	318	236	260	300	321	352	251	278	323	344	381
160	220	243	280	300	331	242	267	310	332	367	258	286	334	357	396
170	225	249	292	310	344	248	274	322	344	382	263	295	345	371	414
180	231	257	301	323	357	253	282	332	356	396	270	303	357	385	429
190	237	263	310	333	371	260	292	343	369	412	277	311	370	398	445
200	242	270	321	344	384	266	299	354	382	426	284	321	382	413	462
210	247	278	330	355	397	271	306	366	394	441	290	329	393	425	479
220	252	286	340	367	412	278	314	376	406	457	297	337	405	440	496
230	258	294	350	379	425	284	324	388	420	473	303	345	418	453	513
240	263	300	360	390	439	292	331	398	432	488	309	354	430	468	530
250	269	307	371	401	453	297	339	411	445	504	316	364	442	482	547
260	277	316	383	416	470	304	349	423	460	522	325	373	457	500	567

Ek ücret:

Kısaç 48300 gri, 48301 beyaz, 48302 siyah: **5,80/Adet**

Fiyatlar



F Slope 1 / F Slope 2

(Hesap temeli: En E, Yükseklik Y1)

Parça adedi	4					4					4				
	110					120					130				
En cm															
Fiyat grubu	0	1	2	3	4	0	1	2	3	4	0	1	2	3	4
Yüks. 80	219	233	257	269	290	230	246	271	285	307	249	265	295	308	333
cm 90	225	242	269	282	306	238	254	285	301	326	255	275	308	326	352
100	232	250	281	298	324	244	264	299	315	343	263	286	324	341	372
110	239	259	295	311	340	251	273	311	331	361	270	296	337	357	392
120	246	268	306	326	356	258	282	326	345	380	278	305	351	374	412
130	252	277	319	340	374	265	293	338	360	398	286	315	366	390	431
140	259	286	331	354	391	272	302	352	376	418	295	327	380	408	452
150	265	295	344	368	409	279	311	366	392	436	302	336	394	424	473
160	271	304	356	383	426	288	322	379	408	455	309	346	410	441	494
170	279	312	369	397	443	295	331	393	423	475	316	356	424	457	514
180	286	323	382	413	461	302	341	406	440	494	325	367	439	476	536
190	294	331	395	426	480	308	351	421	455	514	332	378	454	493	556
200	300	340	409	442	499	316	360	434	473	534	340	388	470	511	577
210	307	350	421	456	516	324	370	449	488	553	349	398	485	527	598
220	313	358	433	473	535	331	381	463	505	572	356	410	501	546	620
230	322	368	448	487	552	339	390	478	521	593	365	420	516	563	641
240	328	378	461	504	571	346	400	493	539	612	372	430	532	581	664
250	335	387	475	518	591	354	412	508	554	634	381	442	547	599	686
260	343	397	491	537	611	363	422	523	573	656	390	455	565	620	711

Parça adedi	4					4					5				
	140					150					160				
En cm															
Fiyat grubu	0	1	2	3	4	0	1	2	3	4	0	1	2	3	4
Yüks. 80	260	278	309	326	351	271	293	326	342	370	284	305	341	359	389
cm 90	268	290	326	342	372	280	303	341	360	392	293	316	358	379	414
100	275	300	340	360	393	289	314	357	379	416	301	329	375	398	436
110	284	310	355	378	415	297	326	374	397	438	309	341	392	419	461
120	293	322	371	395	435	305	337	390	417	461	319	353	410	439	486
130	300	332	386	414	457	314	349	406	435	484	328	365	427	459	511
140	308	343	401	430	480	323	359	423	455	508	337	378	445	480	537
150	316	354	418	449	502	331	371	440	475	531	346	389	463	501	561
160	325	365	432	466	523	340	383	457	494	554	355	401	481	521	586
170	333	375	449	486	546	349	395	475	514	579	365	415	500	542	611
180	341	387	465	505	568	357	406	492	534	602	374	427	518	563	637
190	349	397	481	522	591	366	419	509	553	627	383	440	537	584	664
200	357	410	499	542	613	375	430	525	573	651	392	453	554	605	690
210	366	421	514	561	637	384	443	544	594	676	401	465	573	627	716
220	374	431	531	580	659	393	455	562	613	701	412	479	593	649	742
230	383	444	547	598	684	401	468	580	634	726	421	492	611	671	768
240	391	455	564	619	707	412	480	597	655	752	430	506	631	693	795
250	399	468	581	637	730	420	493	614	676	777	441	518	649	716	822
260	410	481	600	658	757	430	507	635	698	804	452	534	671	738	853

Ek ücret:

Kıskaç 48300 gri, 48301 beyaz, 48302 siyah: **5,80/Adet**

Fiyatlar



F Slope 1 / F Slope 2

(Hesap temeli: En E, Yükseklik Y1)

Parça adedi	5					5					5				
	En cm					En cm					En cm				
Fiyat grubu	170					180					190				
	0	1	2	3	4	0	1	2	3	4	0	1	2	3	4
Yüks. 80	303	326	365	384	416	314	339	381	400	435	329	354	398	421	457
cm 90	311	338	383	403	441	325	352	399	423	462	339	369	419	444	486
100	322	351	400	425	466	334	366	419	445	491	349	383	439	468	515
110	331	364	419	446	494	344	380	439	469	518	359	396	460	492	544
120	340	376	438	469	519	354	393	459	492	546	370	412	481	516	573
130	350	389	456	491	546	365	406	479	515	573	381	425	503	541	602
140	359	401	476	512	572	375	421	500	538	602	391	440	523	564	633
150	369	416	495	535	599	385	433	519	561	631	401	454	545	589	664
160	379	428	514	556	626	395	449	540	584	659	413	469	566	613	693
170	388	442	534	578	653	406	462	561	608	689	423	484	587	638	724
180	398	455	552	600	682	417	478	581	632	718	433	500	609	665	755
190	409	469	572	624	708	426	492	601	656	747	445	514	631	689	785
200	418	482	592	645	735	438	507	623	682	776	456	529	653	715	816
210	428	496	611	669	764	448	521	643	705	806	468	545	675	740	849
220	438	511	632	692	792	459	537	666	730	836	479	561	698	766	880
230	449	523	652	716	819	470	550	687	755	867	491	576	721	792	911
240	459	539	672	738	850	481	565	710	779	898	502	591	743	818	943
250	469	552	693	762	879	492	581	730	805	928	513	606	766	845	976
260	480	567	715	787	909	504	596	754	832	961	524	624	790	873	1009

Parça adedi	5					6					6				
	En cm					En cm					En cm				
Fiyat grubu	200					210					220				
	0	1	2	3	4	0	1	2	3	4	0	1	2	3	4
Yüks. 80	341	369	416	439	478	360	390	440	464	506	376	408	460	487	532
cm 90	352	383	436	463	509	372	405	462	491	539	389	424	485	515	565
100	363	397	458	488	539	384	421	485	517	570	400	441	510	543	599
110	373	413	480	514	569	395	436	509	544	602	414	457	535	571	634
120	384	427	503	540	600	408	453	532	570	635	425	475	559	599	669
130	395	443	524	565	631	419	469	554	597	669	438	492	583	628	704
140	406	458	546	591	664	430	485	578	625	701	450	509	607	656	738
150	418	474	569	615	694	442	502	602	652	735	462	525	633	686	775
160	428	489	592	641	727	454	518	626	681	768	476	543	657	716	810
170	440	505	613	669	759	466	535	650	708	803	488	561	684	744	846
180	452	520	637	695	791	479	551	674	735	837	502	578	710	775	883
190	463	537	662	722	823	491	568	698	764	872	514	596	735	805	919
200	476	552	684	750	857	504	585	723	792	907	526	612	761	835	956
210	487	568	707	776	891	515	601	749	820	942	540	631	787	865	993
220	500	585	731	804	924	527	619	774	851	977	552	649	813	896	1030
230	511	601	755	830	957	541	636	798	880	1013	566	668	840	927	1068
240	522	616	778	858	991	552	653	823	908	1050	580	686	867	957	1106
250	536	634	803	886	1025	566	671	850	938	1084	593	705	895	988	1145
260	547	651	827	915	1061	579	689	877	969	1122	606	723	923	1020	1183

Ek ücret:

Kısaç 48300 gri, 48301 beyaz, 48302 siyah: **5,80/Adet**F Slope 1, F Slope 2
Fiyatlar
4

Boşlukta asılı

COSIFLOR®
 Plise perdeler

FD Slope 3, FD Slope 4

FD Slope 3

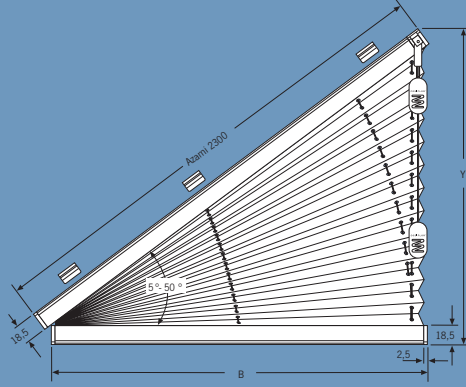

Montaj imkanı:
Dikey

FD Slope 4

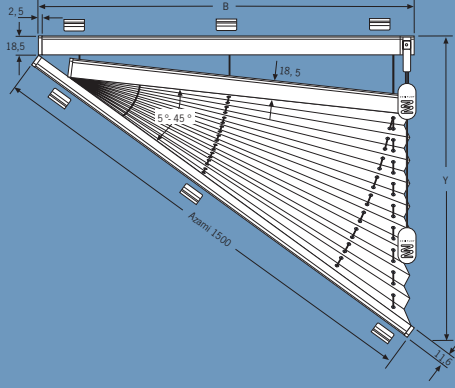

Montaj imkanı:
Dikey

Veriler mm cinsinden

Kullanım (lütfen belirtiniz) :

FD Slope 3

sol üst

sağ üst

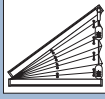

FD Slope 4

sol üst

sağ üst

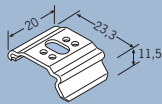
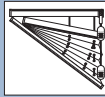
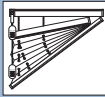

Tavan parçası

48100 gümüş
 48101 beyaz
 48102 siyah

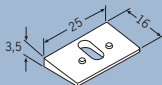

Denge takozu 11°

48114 gri
 48115 beyaz
 48116 braun

Ebat aralığı

FD Slope 3:

Azami Temel en (B) 220 cm*
 Azami eğik en 230 cm
 Azami yükseklik (Y) 160 cm

Asgari temel en (E) 30 cm
 Asgari yükseklik (Y) 30 cm

Neigungswinkel 5° - 50°

* Kumaş enine bağlı

Bkz. Grafik Sf. 4.9

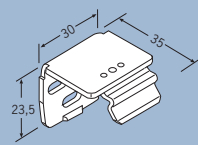

Duvar parçası

48200 gümüş
 48201 beyaz
 48202 siyah

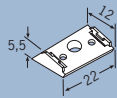

Denge takoz 15°

48110 beyaz
 48111 siyah

Ebat aralığı:

FD Slope 4:

Azami en (E) (B) 100 cm
 Azami yükseklik (Y) 100 cm

Asgari en (B) 30 cm
 Asgari yükseklik (Y): 30 cm

Neigungswinkel 5° - 45°

Bkz. Grafik Sf. 4.9

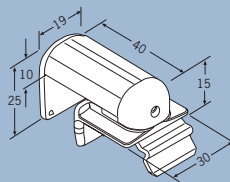

Kısaç

48300 gri
 48301 beyaz
 48302 siyah
Ek ücret: 5,80/Adet

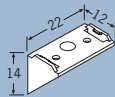

Denge takozu 45°

48112 beyaz
 48113 siyah

FD Slope 3

Tertibat

yükseklikleri:



50 cm

100 cm

150 cm

200 cm

260 cm

Paket

yükseklikleri

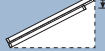

ca. 7 cm

ca. 8 cm

ca. 9 cm

ca. 10 cm

ca. 11 cm

FD Slope 4

Tertibat

yükseklikleri:

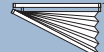

50 cm

100 cm

Paket

yükseklikleri

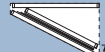

ca. 6 cm

ca. 7 cm

Fiyatlar



FD Slope 3, FD Slope 4

(Hesap temeli: En E, Yükseklik Y1)

Parça adedi	3/6					3/6					3/6				
	50					60					70				
En cm															
Fiyat grubu	0	1	2	3	4	0	1	2	3	4	0	1	2	3	4
Yüks. 80	138	144	153	159	168	147	155	167	173	183	157	165	180	186	200
cm 90	142	148	160	167	176	152	160	174	181	193	161	172	187	197	210
100	146	152	167	172	184	156	164	181	188	203	165	177	197	206	220
110	150	159	172	180	192	160	171	187	198	212	171	182	204	214	232
120	152	163	180	187	201	163	176	197	206	221	175	188	212	223	243
130	156	169	184	194	209	168	181	203	213	231	179	194	220	232	253
140	162	173	192	204	218	173	186	210	222	242	183	201	228	242	265
150	167	178	201	209	227	177	192	218	230	251	187	206	237	251	275
160	171	182	205	216	237	180	198	224	239	262	193	212	245	261	289

Parça adedi	3/6					4/6					4/7				
	80					90					100				
En cm															
Fiyat grubu	0	1	2	3	4	0	1	2	3	4	0	1	2	3	4
Yüks. 80	179	188	206	214	228	197	208	227	236	252	209	221	243	253	271
cm 90	184	197	214	224	241	203	214	237	248	266	214	229	253	266	288
100	188	203	223	235	252	208	222	247	259	280	220	237	264	279	302
110	194	209	233	246	266	213	229	257	271	295	227	245	275	293	318
120	200	215	243	255	278	219	237	268	284	308	232	253	289	305	333
130	205	222	252	267	293	224	245	278	296	324	239	261	300	318	349
140	210	229	261	278	304	230	252	290	307	337	245	269	310	331	365
150	215	236	270	289	318	236	260	300	321	352	251	278	323	344	381
160	220	243	280	300	331	242	267	310	332	367	258	286	334	357	396

Parça adedi	4/7					4/8					4/8				
	110					120					130				
En cm															
Fiyat grubu	0	1	2	3	4	0	1	2	3	4	0	1	2	3	4
Yüks. 80	219	233	257	269	290	230	246	271	285	307	249	265	295	308	333
cm 90	225	242	269	282	306	238	254	285	301	326	255	275	308	326	352
100	232	250	281	298	324	244	264	299	315	343	263	286	324	341	372
110	239	259	295	311	340	251	273	311	331	361	270	296	337	357	392
120	246	268	306	326	356	258	282	326	345	380	278	305	351	374	412
130	252	277	319	340	374	265	293	338	360	398	286	315	366	390	431
140	259	286	331	354	391	272	302	352	376	418	295	327	380	408	452
150	265	295	344	368	409	279	311	366	392	436	302	336	394	424	473
160	271	304	356	383	426	288	322	379	408	455	309	346	410	441	494

Ek ücret:

Kıskaç 48300 gri, 48301 beyaz, 48302 siyah: **5,80/Adet**

Fiyatlar



FD Slope 3, FD Slope 4

(Hesap temeli: En E, Yükseklik Y1)

Parça adedi	5/8					5/8					5/8				
	En cm					En cm					En cm				
Fiyat grubu	140					150					160				
	0	1	2	3	4	0	1	2	3	4	0	1	2	3	4
Yüks. 80	260	278	309	326	351	271	293	326	342	370	284	305	341	359	389
cm 90	268	290	326	342	372	280	303	341	360	392	293	316	358	379	414
100	275	300	340	360	393	289	314	357	379	416	301	329	375	398	436
110	284	310	355	378	415	297	326	374	397	438	309	341	392	419	461
120	293	322	371	395	435	305	337	390	417	461	319	353	410	439	486
130	300	332	386	414	457	314	349	406	435	484	328	365	427	459	511
140	308	343	401	430	480	323	359	423	455	508	337	378	445	480	537
150	316	354	418	449	502	331	371	440	475	531	346	389	463	501	561
160	325	365	432	466	523	340	383	457	494	554	355	401	481	521	586

Parça adedi	5/10					5/10					5/10				
	En cm					En cm					En cm				
Fiyat grubu	170					180					190				
	0	1	2	3	4	0	1	2	3	4	0	1	2	3	4
Yüks. 80	303	326	365	384	416	314	339	381	400	435	329	354	398	421	457
cm 90	311	338	383	403	441	325	352	399	423	462	339	369	419	444	486
100	322	351	400	425	466	334	366	419	445	491	349	383	439	468	515
110	331	364	419	446	494	344	380	439	469	518	359	396	460	492	544
120	340	376	438	469	519	354	393	459	492	546	370	412	481	516	573
130	350	389	456	491	546	365	406	479	515	573	381	425	503	541	602
140	359	401	476	512	572	375	421	500	538	602	391	440	523	564	633
150	369	416	495	535	599	385	433	519	561	631	401	454	545	589	664
160	379	428	514	556	626	395	449	540	584	659	413	469	566	613	693

Parça adedi	6/12					6/12					6/12				
	En cm					En cm					En cm				
Fiyat grubu	200					210					220				
	0	1	2	3	4	0	1	2	3	4	0	1	2	3	4
Yüks. 80	341	369	416	439	478	360	390	440	464	506	376	408	460	487	532
cm 90	352	383	436	463	509	372	405	462	491	539	389	424	485	515	565
100	363	397	458	488	539	384	421	485	517	570	400	441	510	543	599
110	373	413	480	514	569	395	436	509	544	602	414	457	535	571	634
120	384	427	503	540	600	408	453	532	570	635	425	475	559	599	669
130	395	443	524	565	631	419	469	554	597	669	438	492	583	628	704
140	406	458	546	591	664	430	485	578	625	701	450	509	607	656	738
150	418	474	569	615	694	442	502	602	652	735	462	525	633	686	775
160	428	489	592	641	727	454	518	626	681	768	476	543	657	716	810

Ek ücret:

Kıskaç 48300 gri, 48301 beyaz, 48302 siyah: **5,80/Adet**

F Slope 1, F Slope 2, FD Slope 3, FD Slope 4

Montaj

Pervaz montajda veya duvara montajda lütfen iç ebadı ve istenen çıkmaı belirtiniz. Mevcut teçhizata dikkat ediniz.

X = istenen çıkma

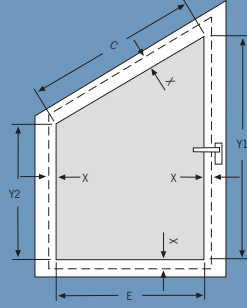

1. Eğri pervaz

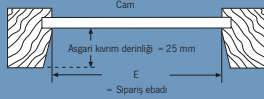

2. Düz pervaz

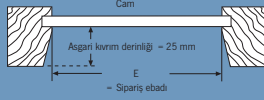

F Slope 1/ F Slope 2

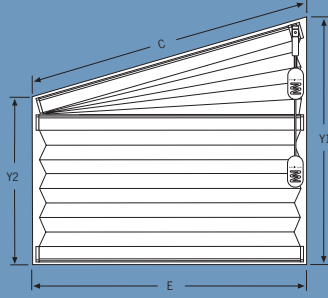

FD Slope 3

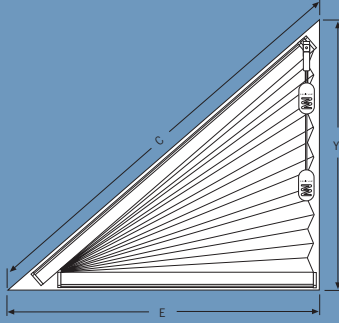

FD Slope 4

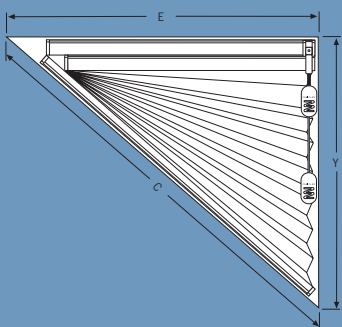

Cam kırımına montajda ölçü alımı (Oyuk montajı)

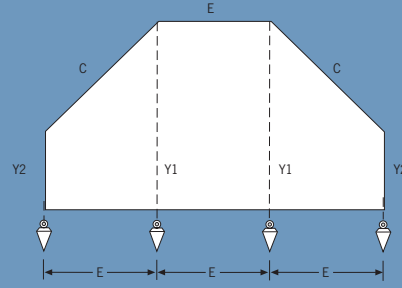

İç ebatlar çekül tutarak bulunur.

Lütfen sadece iç ebatları belirtiniz, kesintiler fabrika tarafından hesaplanır.

C ebadı, kontrol ebadı olarak alınır. Ebatları itinayla belirleyiniz, çünkü ancak bu sayede açılı tam olarak tespit edilebilir.

Ebat E: En

Ebat Y 1: Büyük yükseklik

Ebat Y 2: Küçük yükseklik

Ebat C: Eğimli en (Ray ebadı değil)

F Slope 1/ F Slope 2

Raylar

Alüminyumdan,
Gümüş anotlamalı,
Beyaz boyalı,
Siyah-kahverengi veya pirinç anotlamalı.

Montaj imkanı:

Dikey



FD Slope 3

Raylar

Alüminyumdan,
Gümüş anotlamalı,
Beyaz boyalı,
Siyah-kahverengi veya pirinç anotlamalı.

Montaj imkanı:

Dikey



FD Slope 4

Raylar

Alüminyumdan,
Gümüş anotlamalı,
Beyaz boyalı,
Siyah-kahverengi anotlamalı veya Pirinç anotlamalı.

Montaj imkanı:

Dikey



Ebat bilgileri

F Slope 1, F Slope 2, FD Slope 3, FD Slope 4

Tertibatlar arasındaki ışık aralığı (kumaş-boşluk) yakl. 10 mm. Gereken ray mesafesi fabrika tarafından belirlenir.

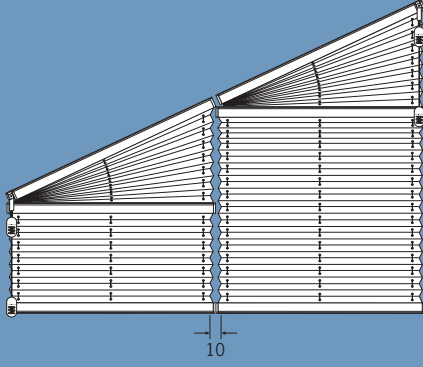

**Dikkat:**

Farklı bir istek olmaması halinde:
Kumaş eni = Ray eni

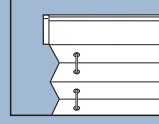
Uç kapakları dışarı sarkar! !



Slope model seçimi grafiği

-  Ebat aralığı Slope 1
-  Ebat aralığı Slope 4
-  Ebat aralığı Slope 2 ve Slope 3

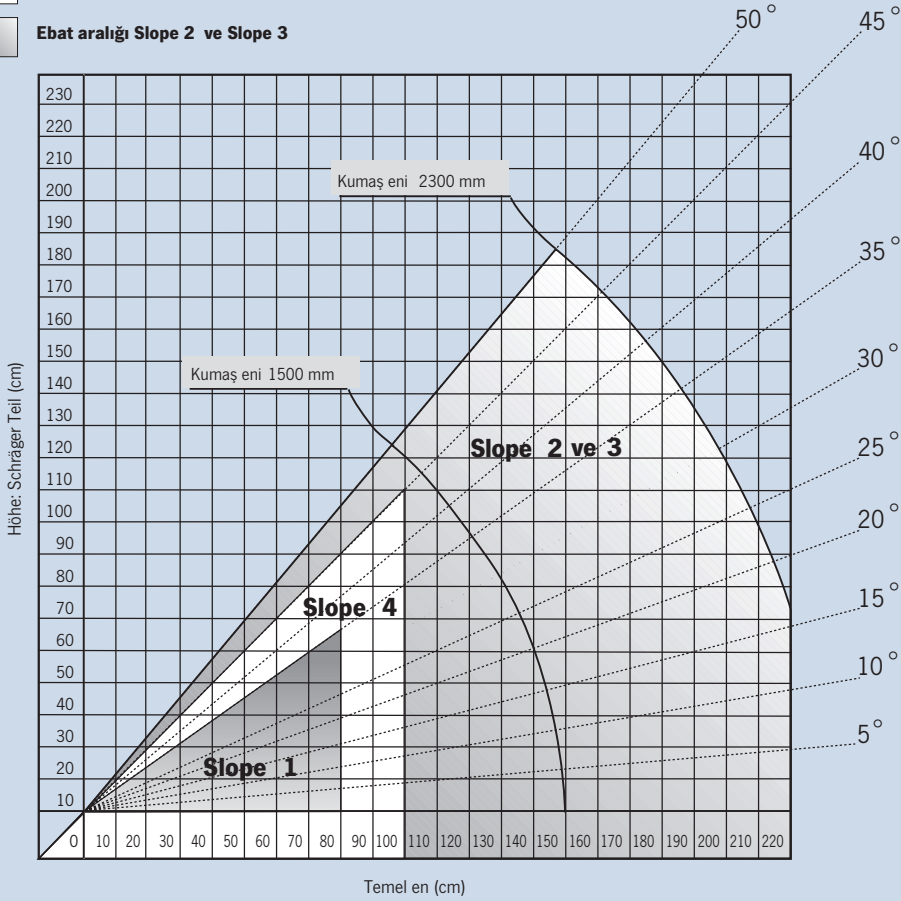

Yükseklik: Eğik kısım = Y1 eksi Y2 (bkz. Şekil Sayfa 4.8).